

PAPER  
**FOX**  
White Sheet

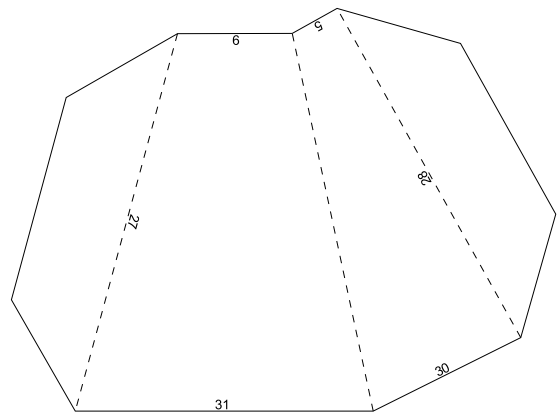

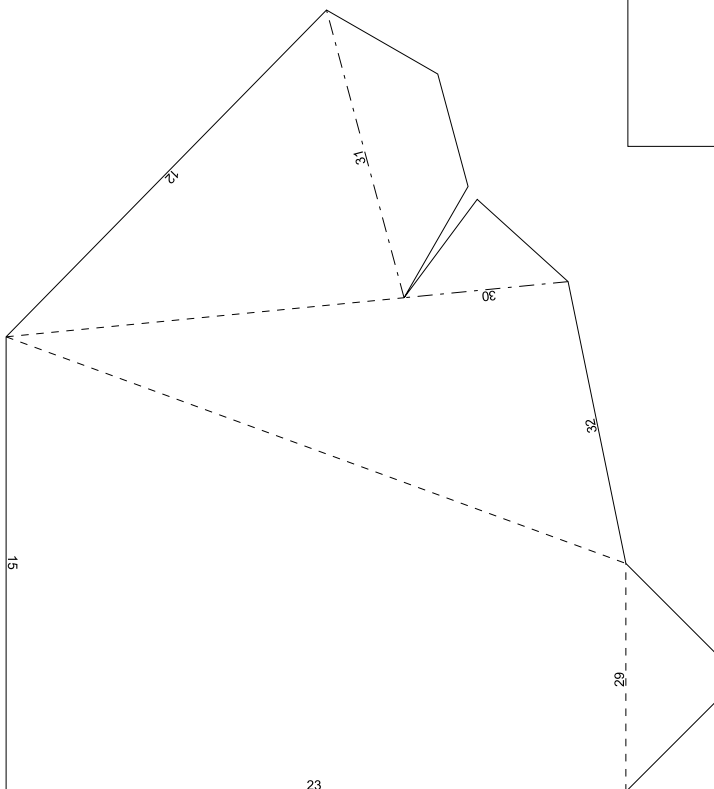
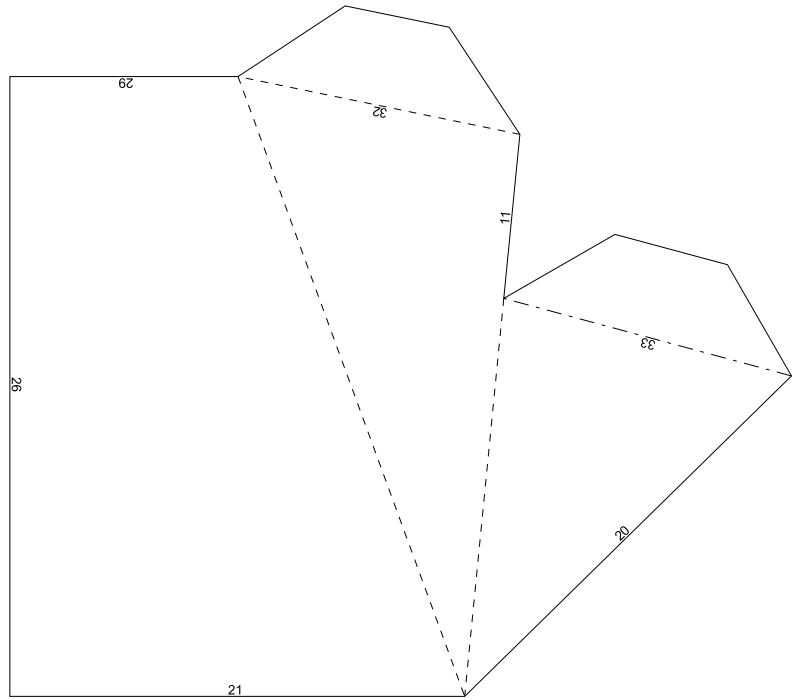
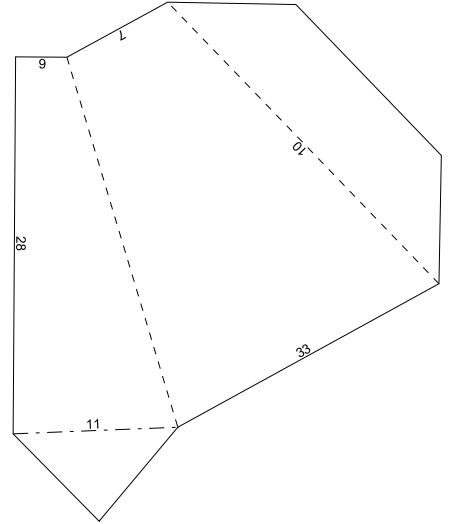
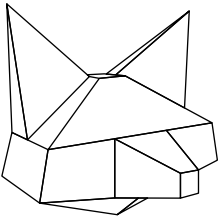

# PAPER **FOX**

Orange Sheet

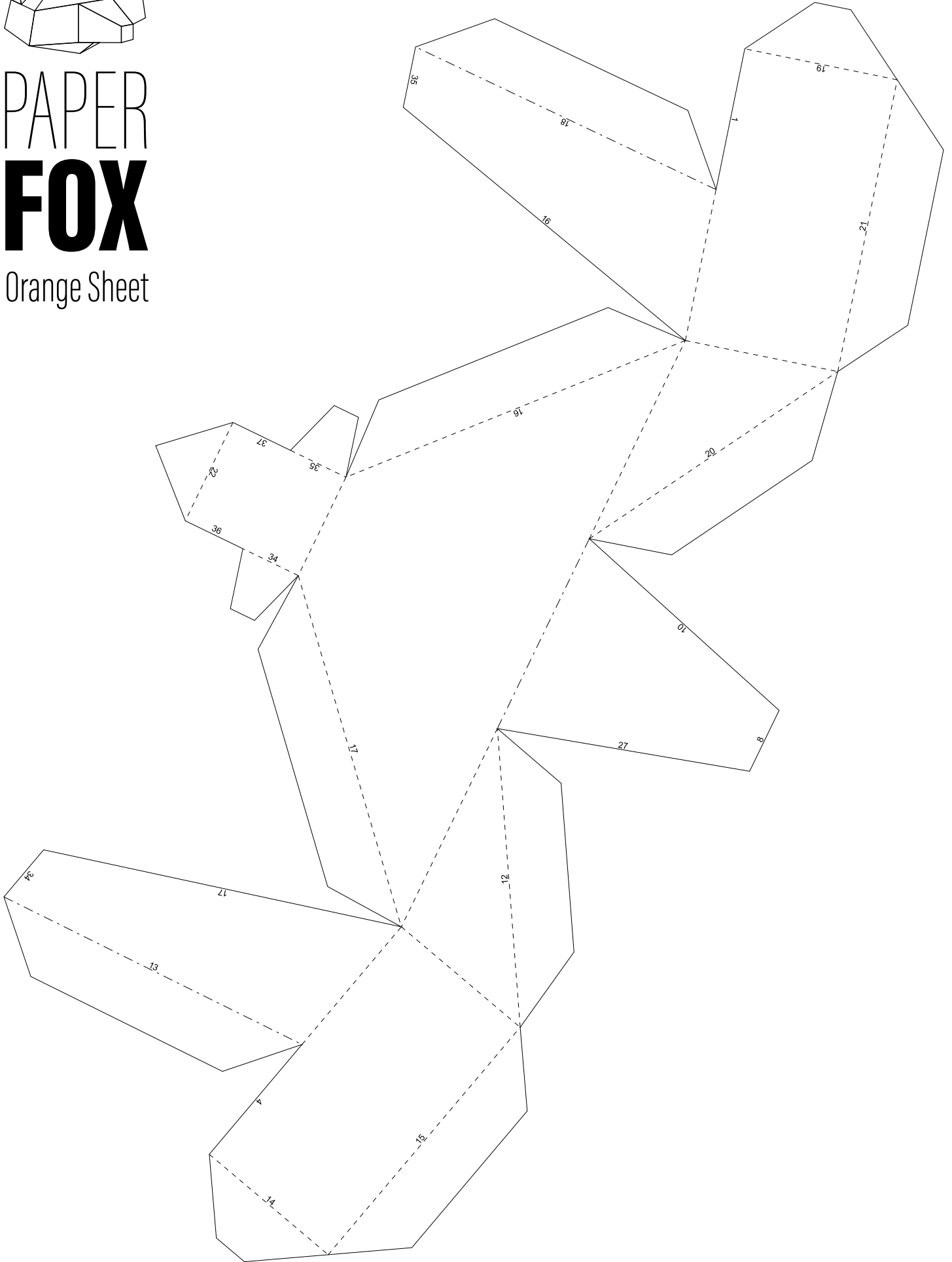

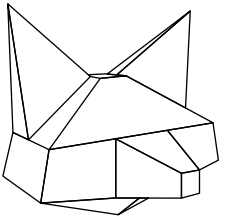

# PAPER **FOX**

Orange Sheet

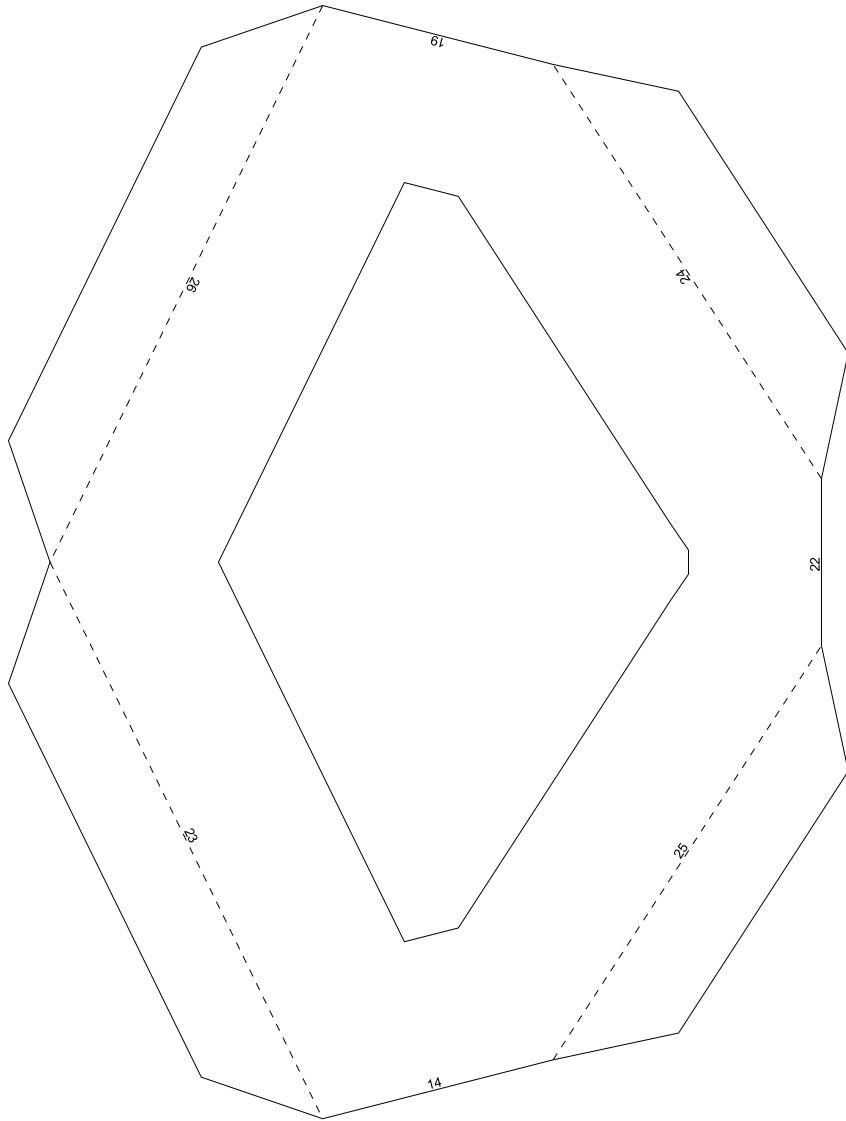

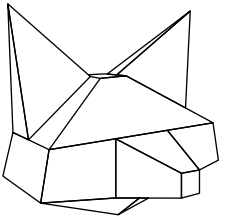

PAPER  
**FOX**  
Brown Sheet

